

**Flush W100
Classic Series**

W =	_____
X =	_____
Y =	_____
Z =	_____

for sizes available refer to
Custom Sizing Chart

(not to scale)

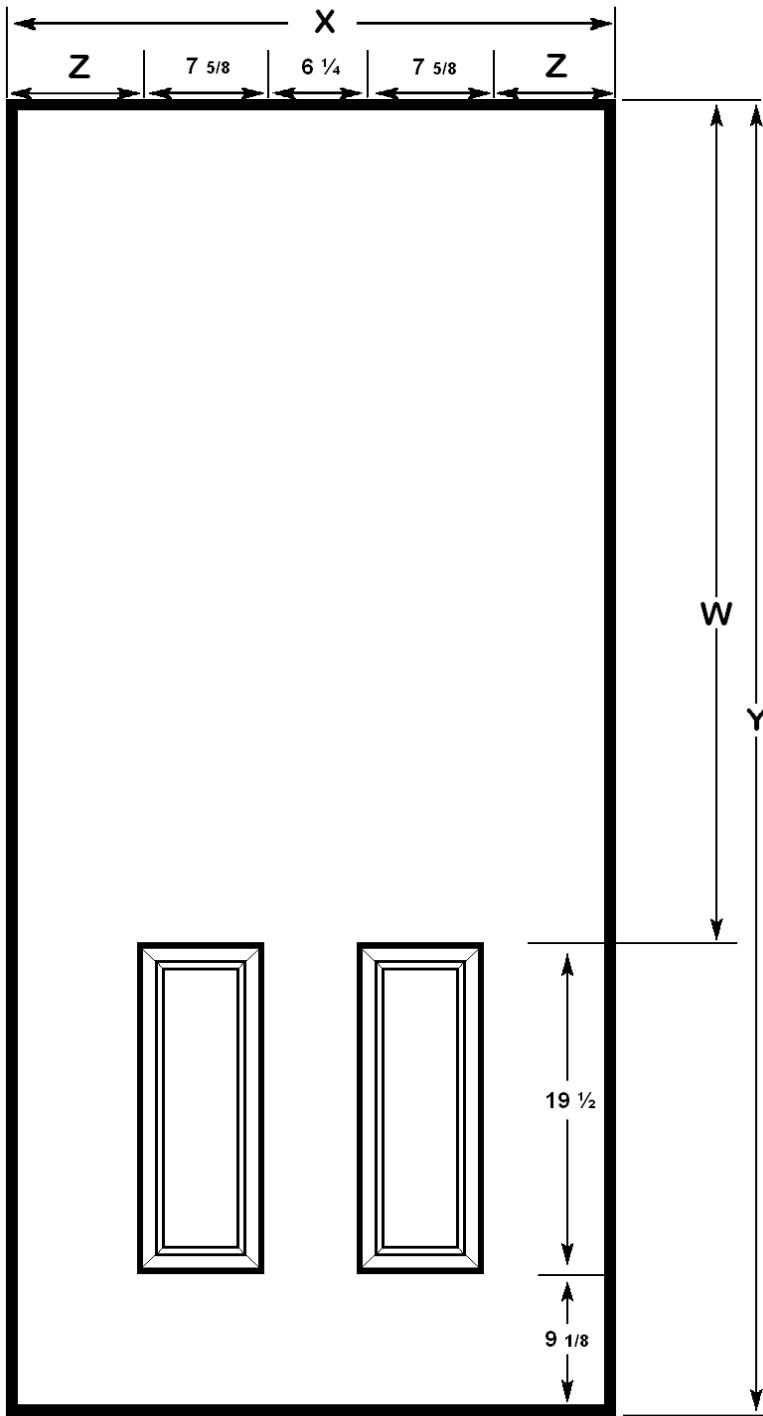

2 Panel W200
Classic Series

W =	_____
X =	_____
Y =	_____
Z =	_____

for sizes available refer to
Custom Sizing Chart

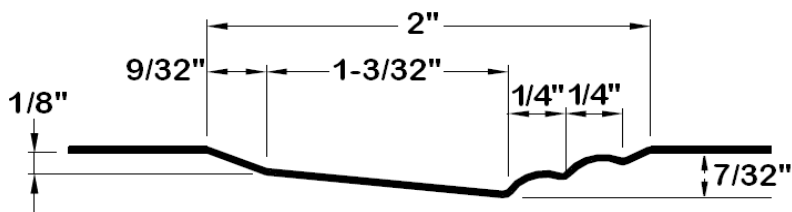

(not to scale)

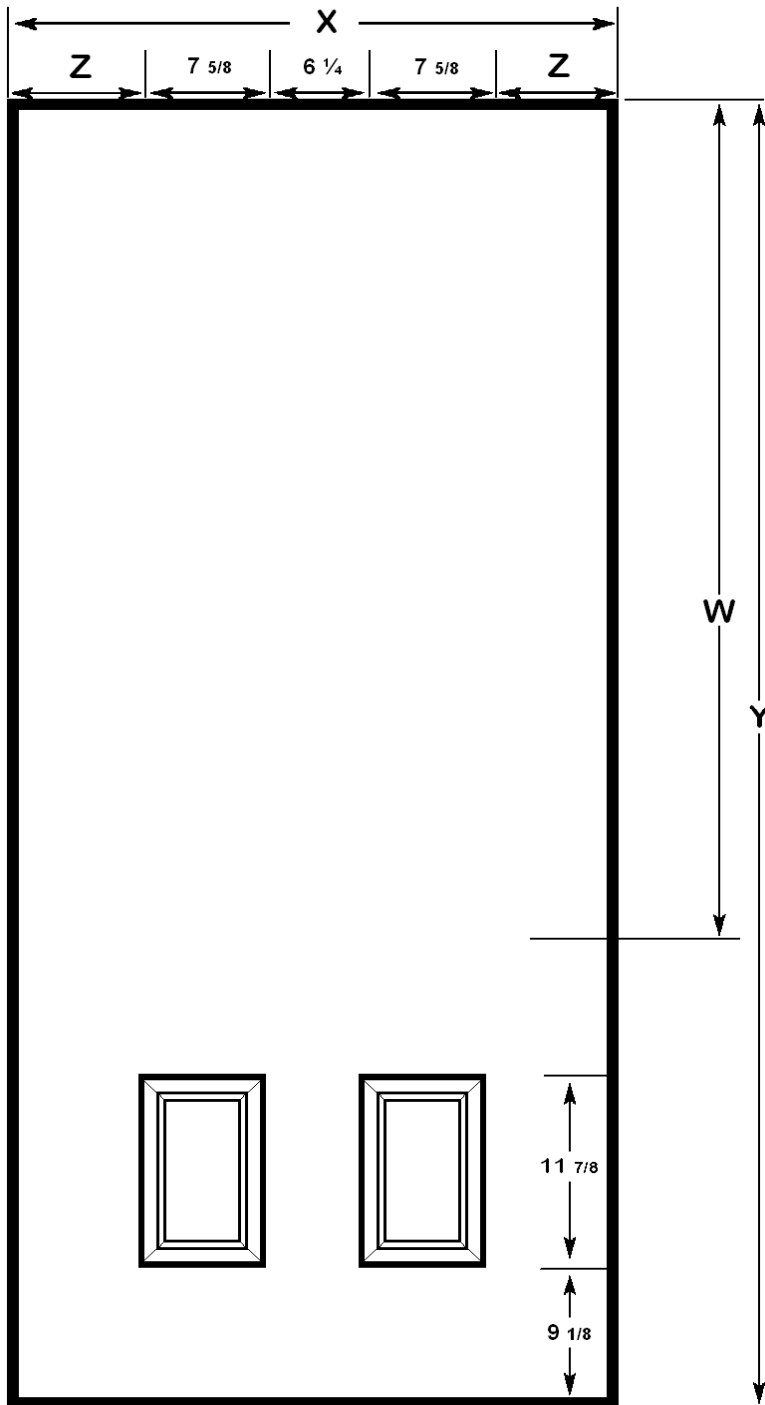

2 Small Panel W2100
Classic Series

W =	_____
X =	_____
Y =	_____
Z =	_____

for sizes available refer to
Custom Sizing Chart

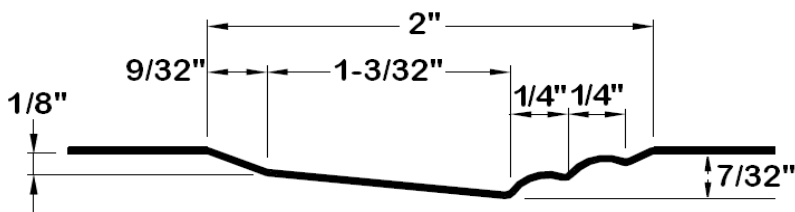

(not to scale)

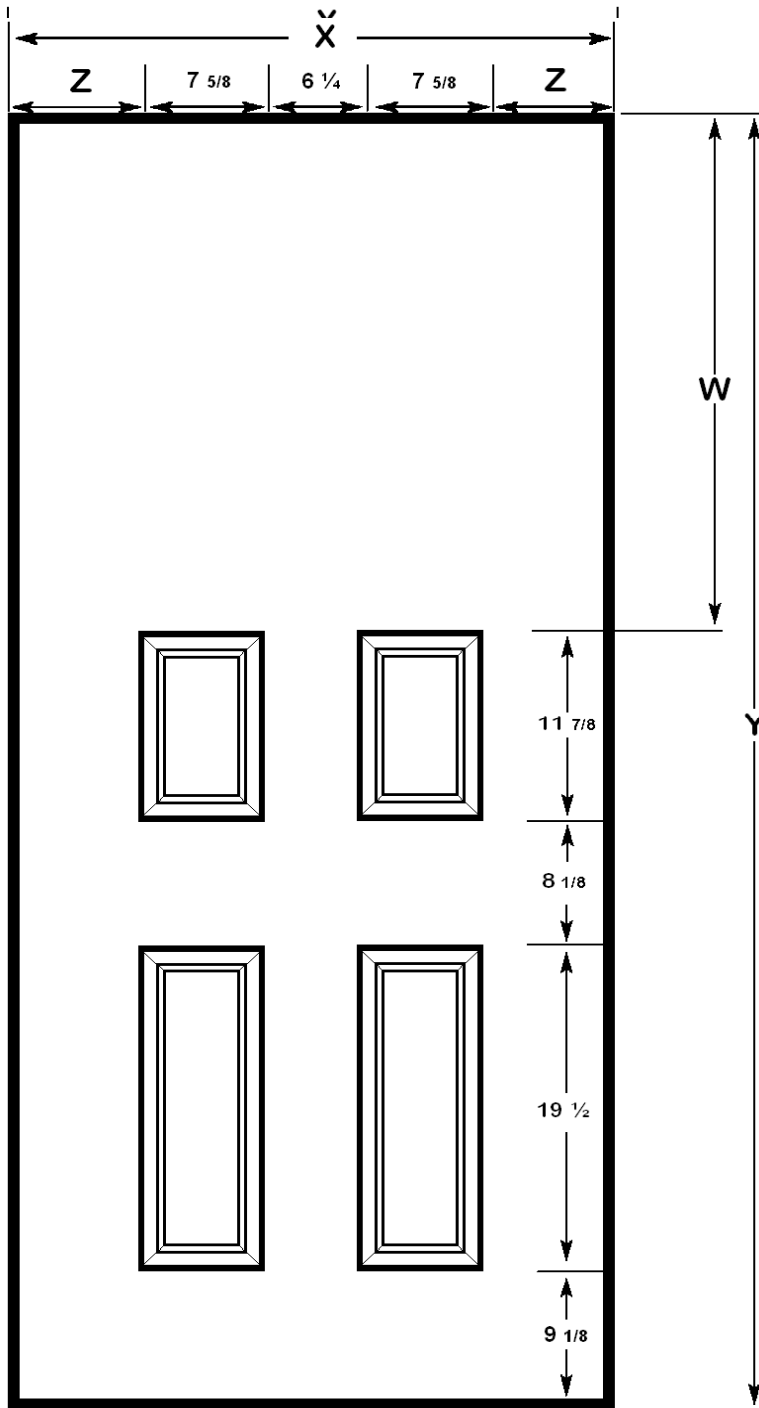

2+2 Panel W2200
Classic Series

W =	_____
X =	_____
Y =	_____
Z =	_____

for sizes available refer to
Custom Sizing Chart

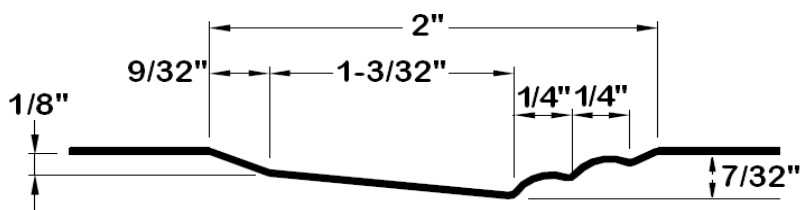

(not to scale)

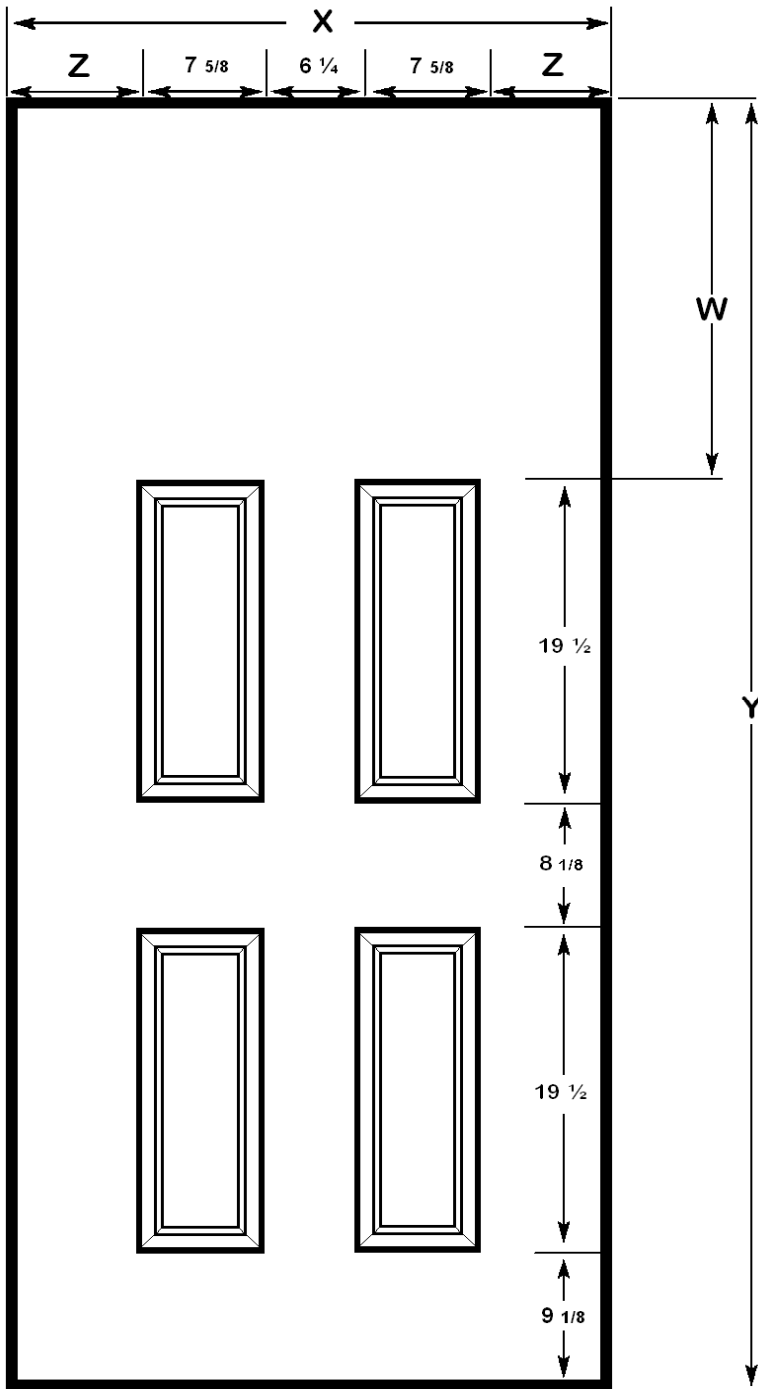

4 Panel W400
Classic Series

W =	_____
X =	_____
Y =	_____
Z =	_____

for sizes available refer to
Custom Sizing Chart

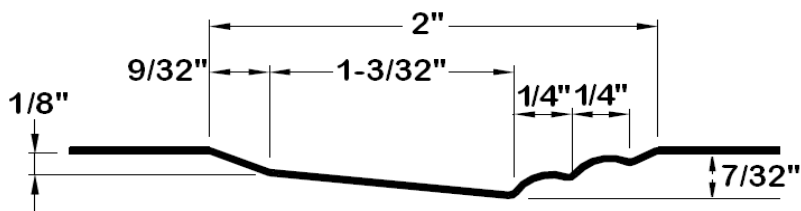

(not to scale)

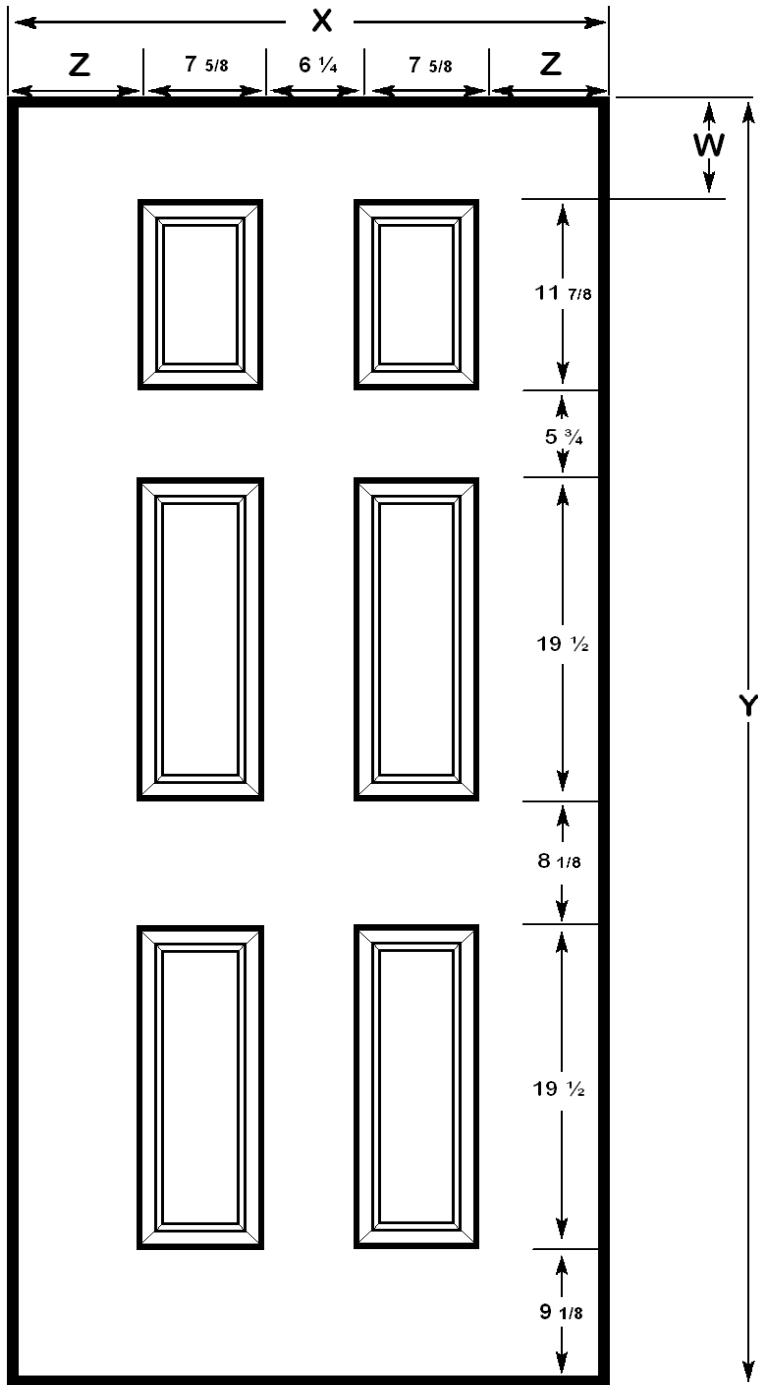

6 Panel W600
Classic Series

W =	_____
X =	_____
Y =	_____
Z =	_____

for sizes available refer to
Custom Sizing Chart

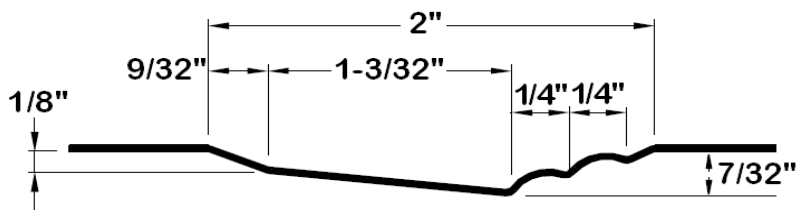

(not to scale)

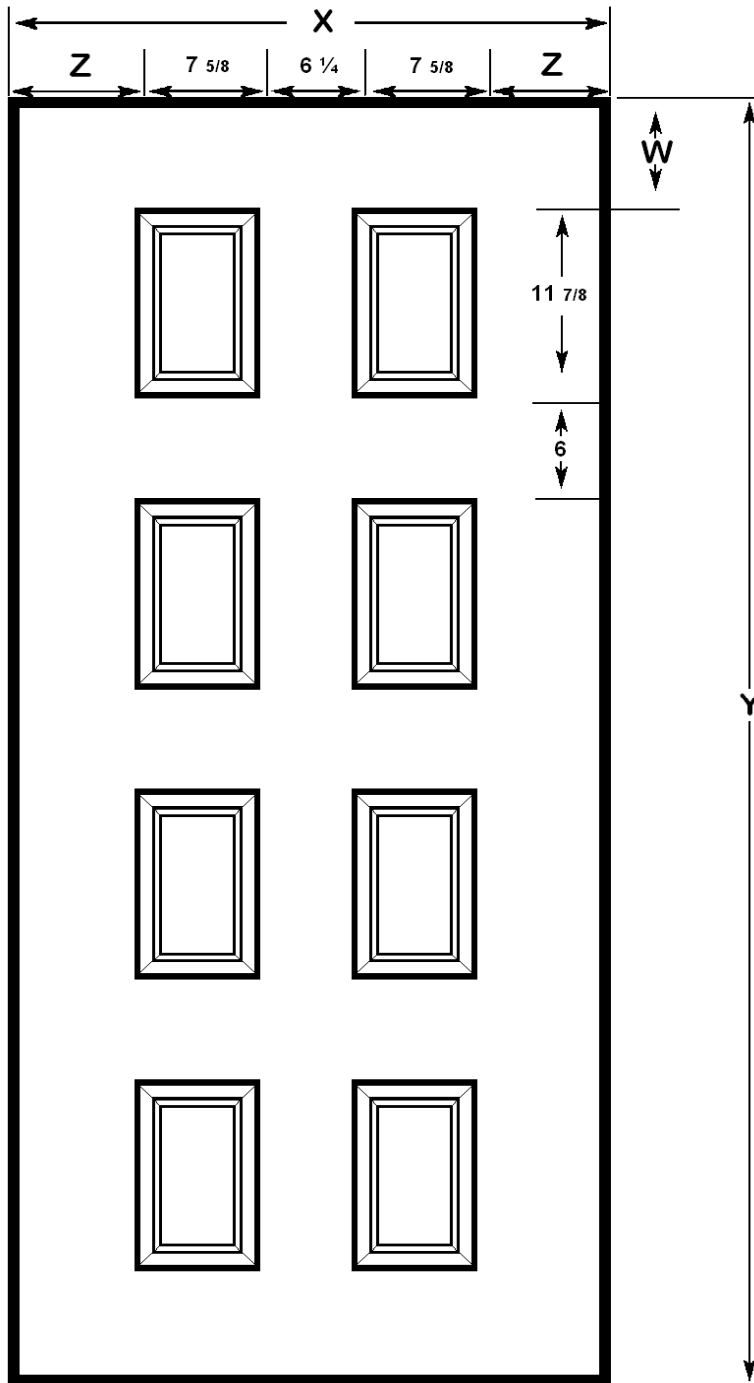

8 Panel W800
Classic Series

W =	_____
X =	_____
Y =	_____
Z =	_____

for sizes available refer to
Custom Sizing Chart

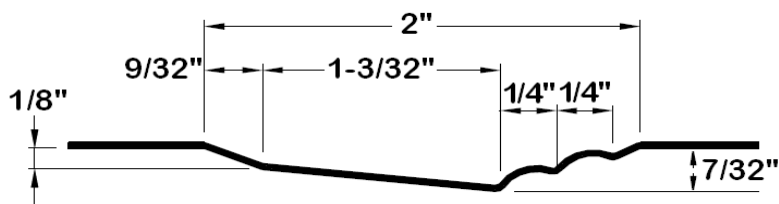

(not to scale)

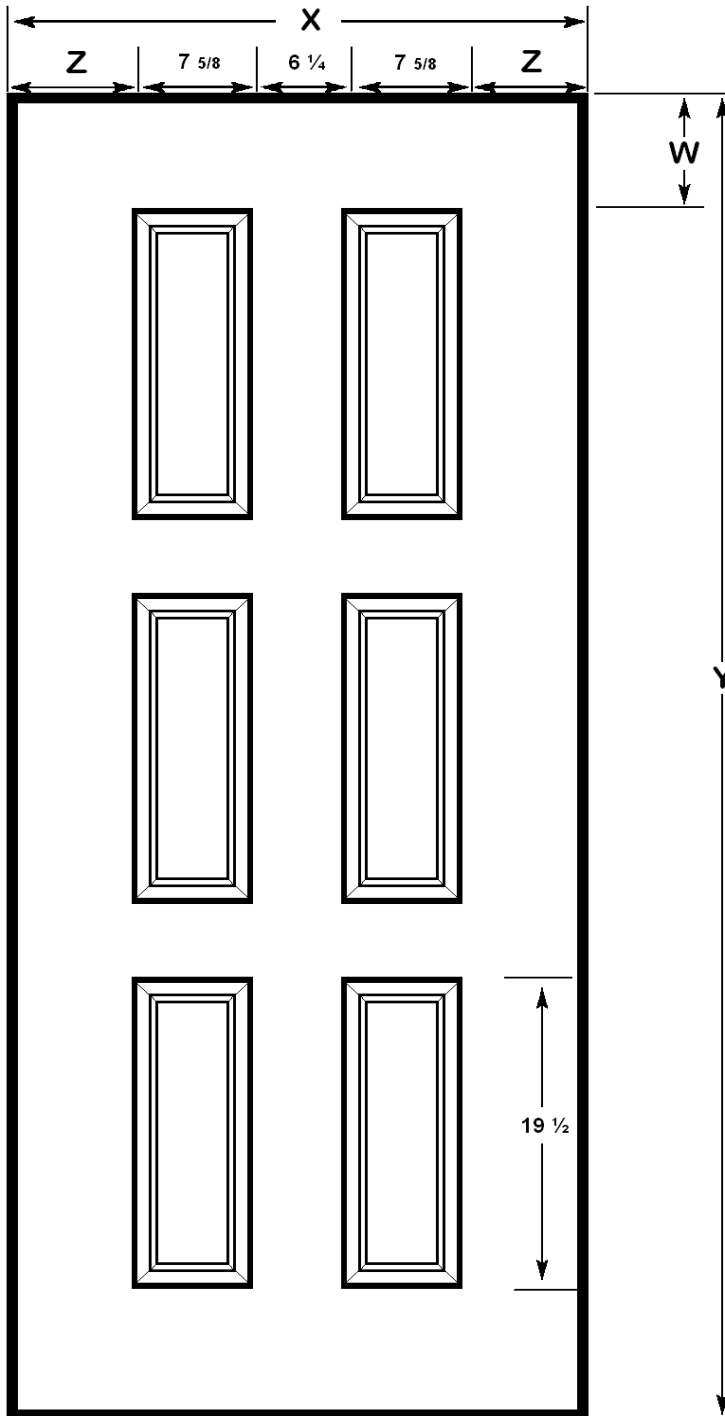

6 Equal Panel W660
Classic Series

W =	_____
X =	_____
Y =	_____
Z =	_____

for sizes available refer to
Custom Sizing Chart

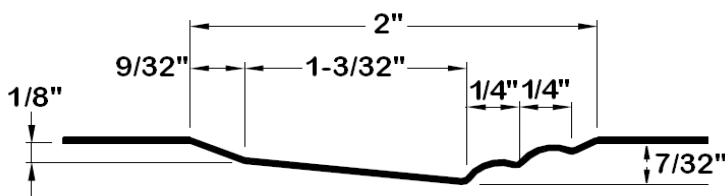

(not to scale)

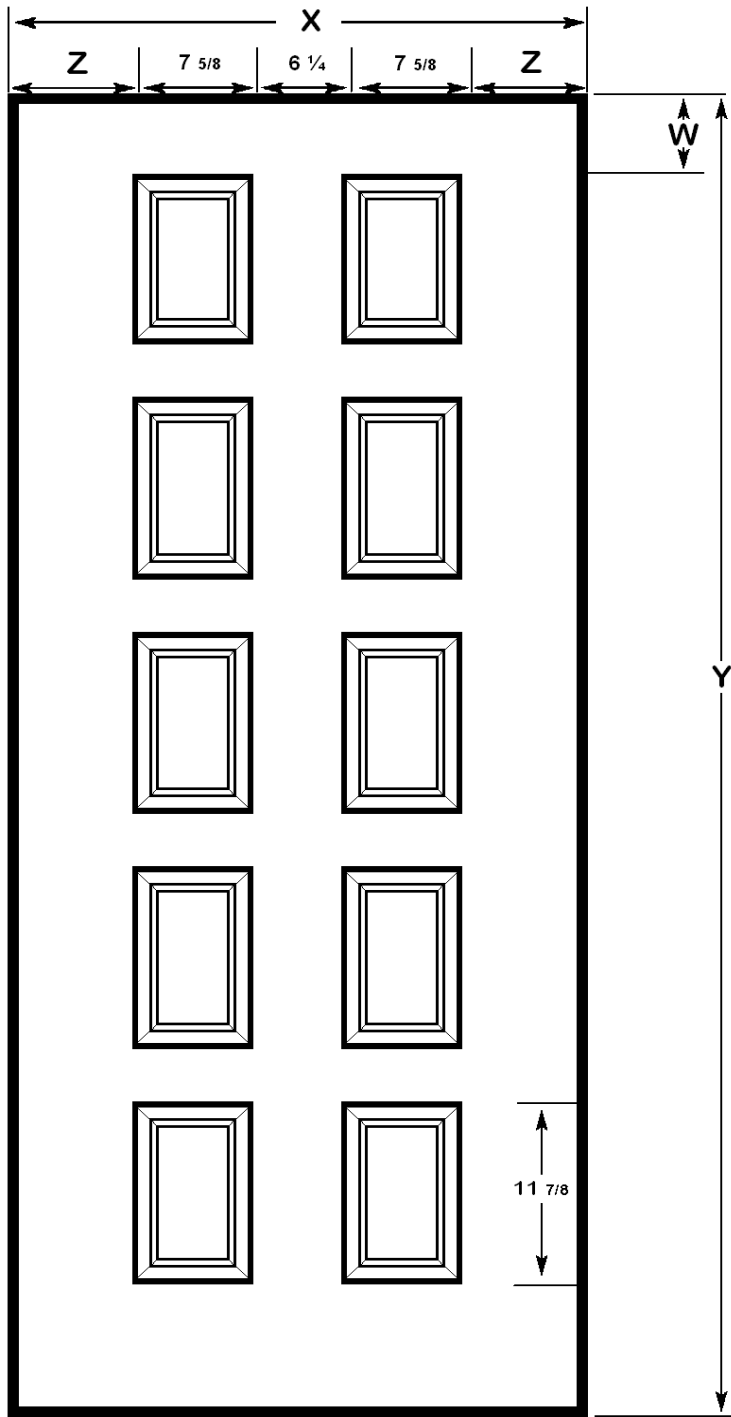

10 Panel W1000
Classic Series

W =	_____
X =	_____
Y =	_____
Z =	_____

for sizes available refer to Custom Sizing Chart

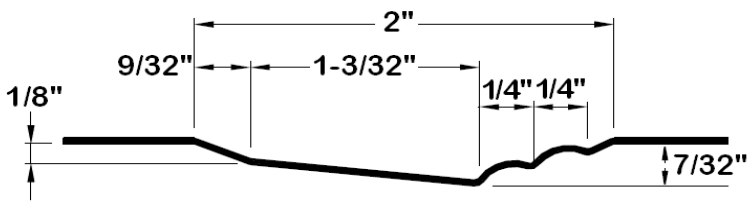

(not to scale)

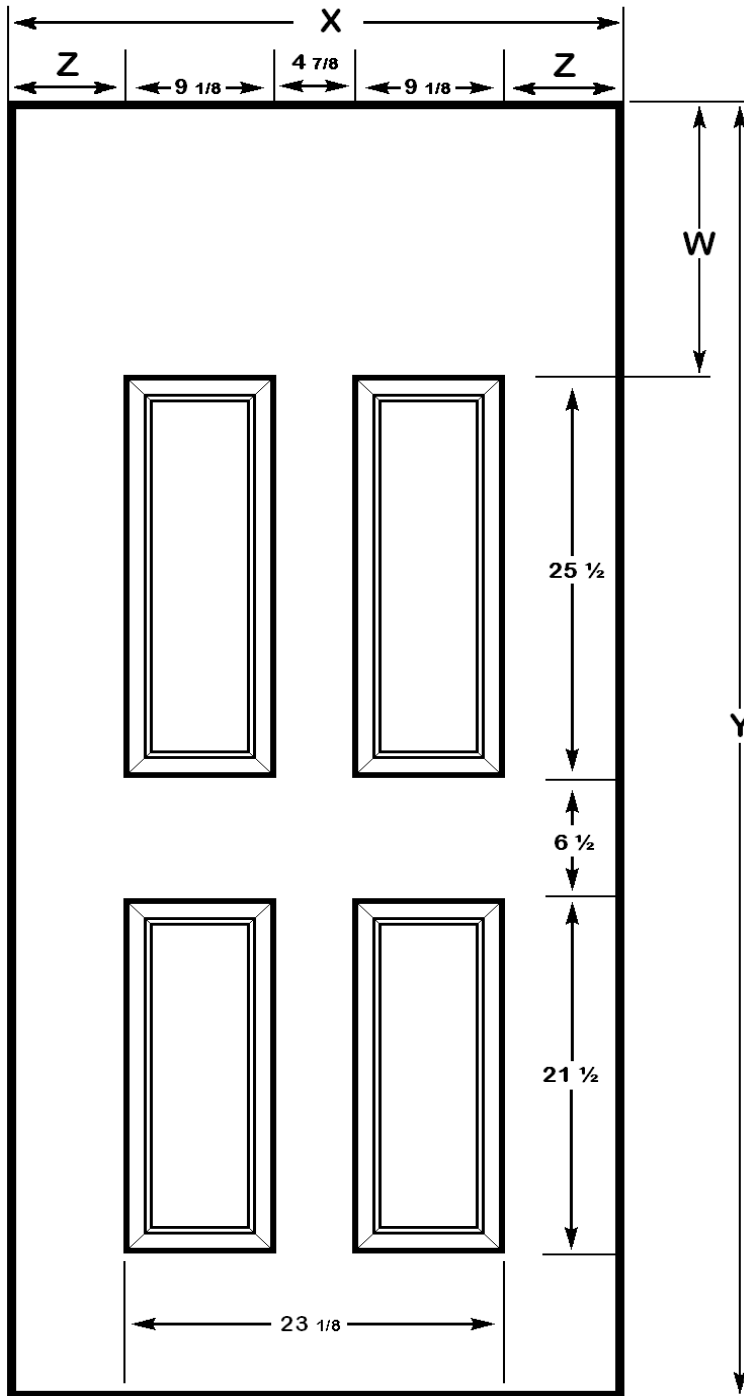

**4 Panel WA400
Americana Series**

W =	_____
X =	_____
Y =	_____
Z =	_____

for sizes available refer to
Custom Sizing Chart

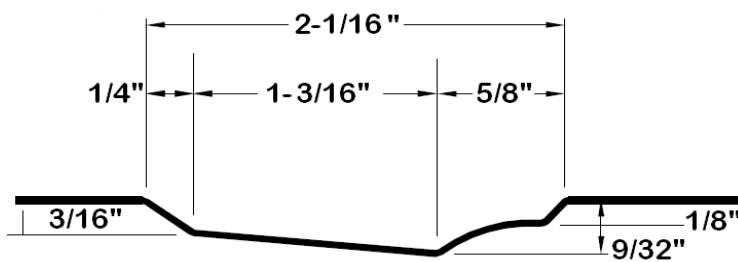

(not to scale)

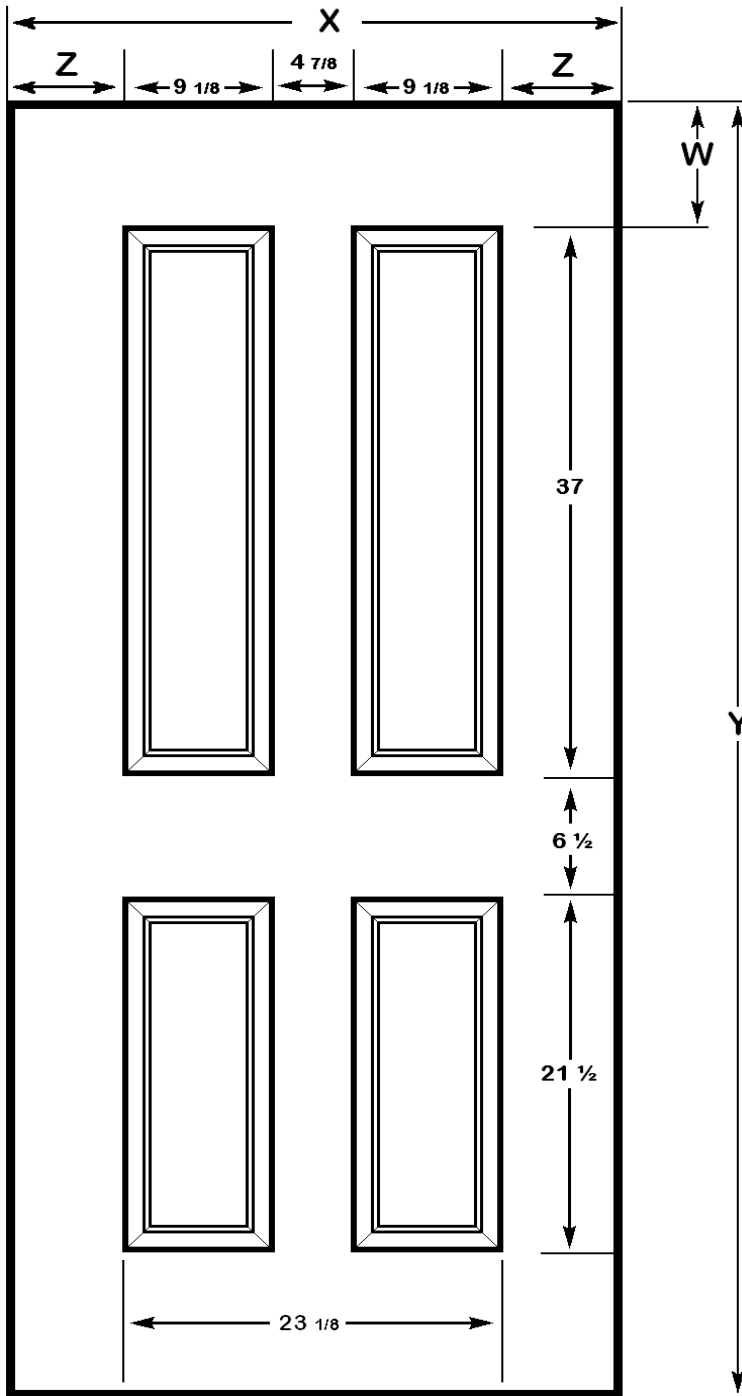

4 Panel WA4400
Americana Series

W =	_____
X =	_____
Y =	_____
Z =	_____

for sizes available refer to
Custom Sizing Chart

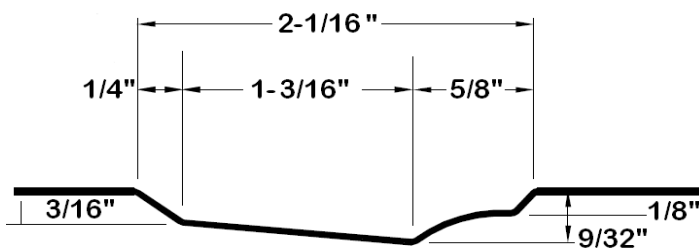

(not to scale)

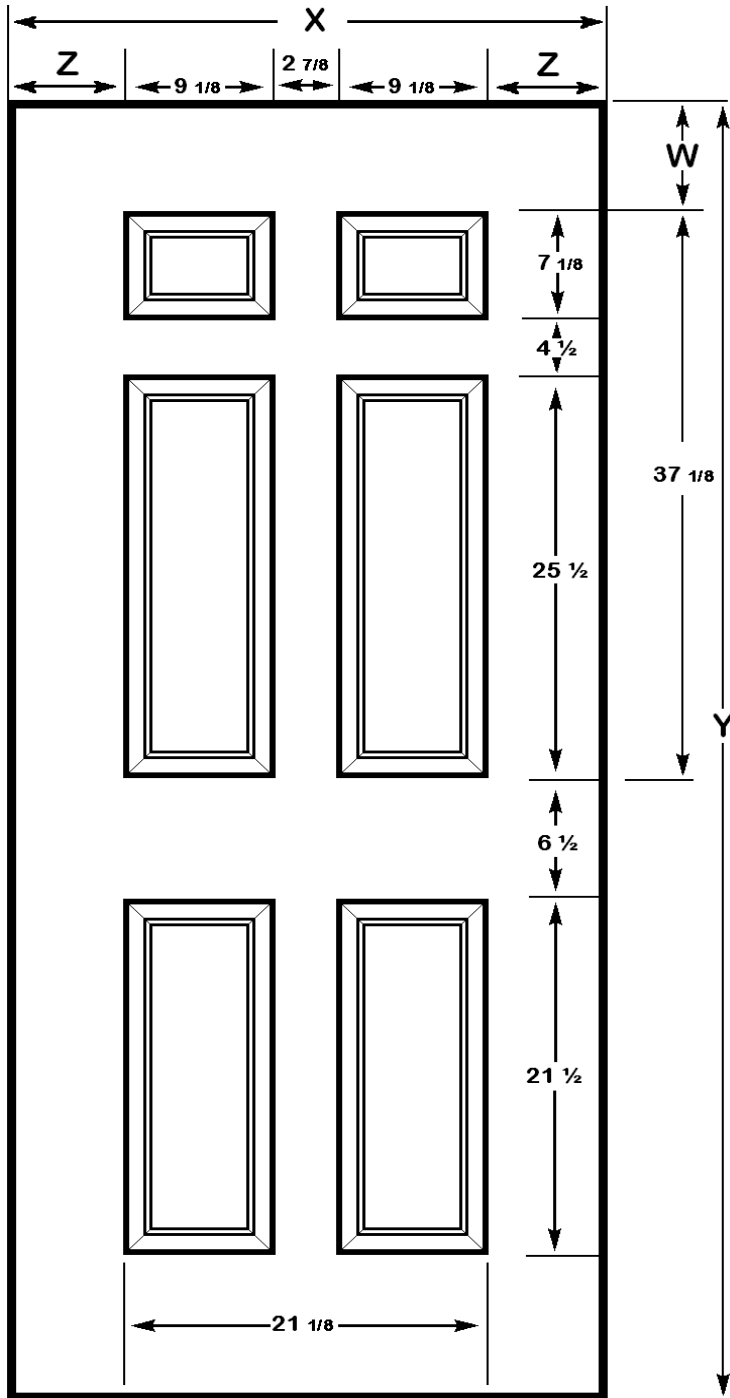

6 Pnl WA600
Narrow (30" wide)
Americana Series

W =	_____
X =	_____
Y =	_____
Z =	_____

for sizes available refer to
Custom Sizing Chart

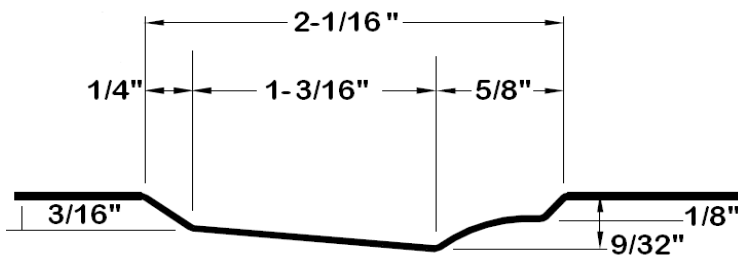

(not to scale)

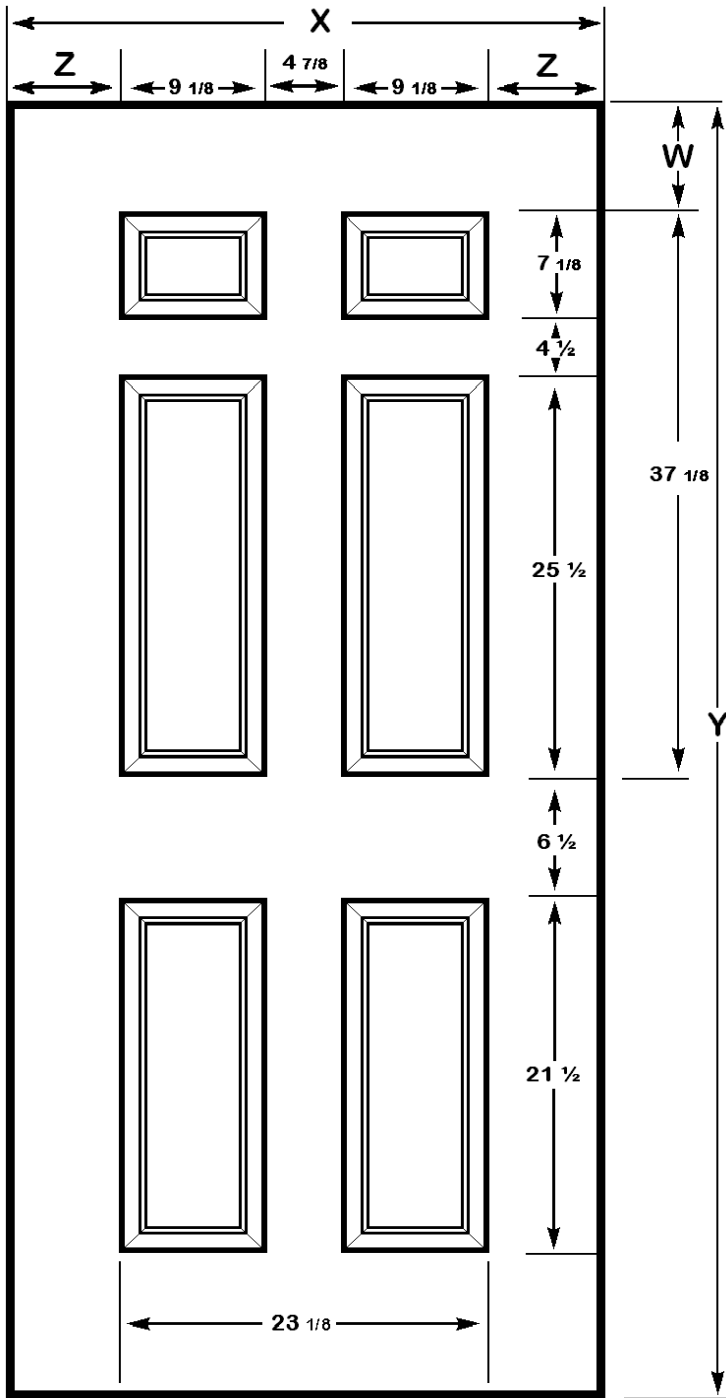

6 Panel WA600
Regular (80")
Americana Series

W =	_____
X =	_____
Y =	_____
Z =	_____

for sizes available refer to
Custom Sizing Chart

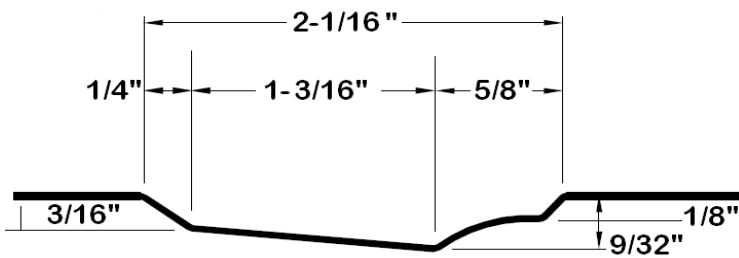

(not to scale)

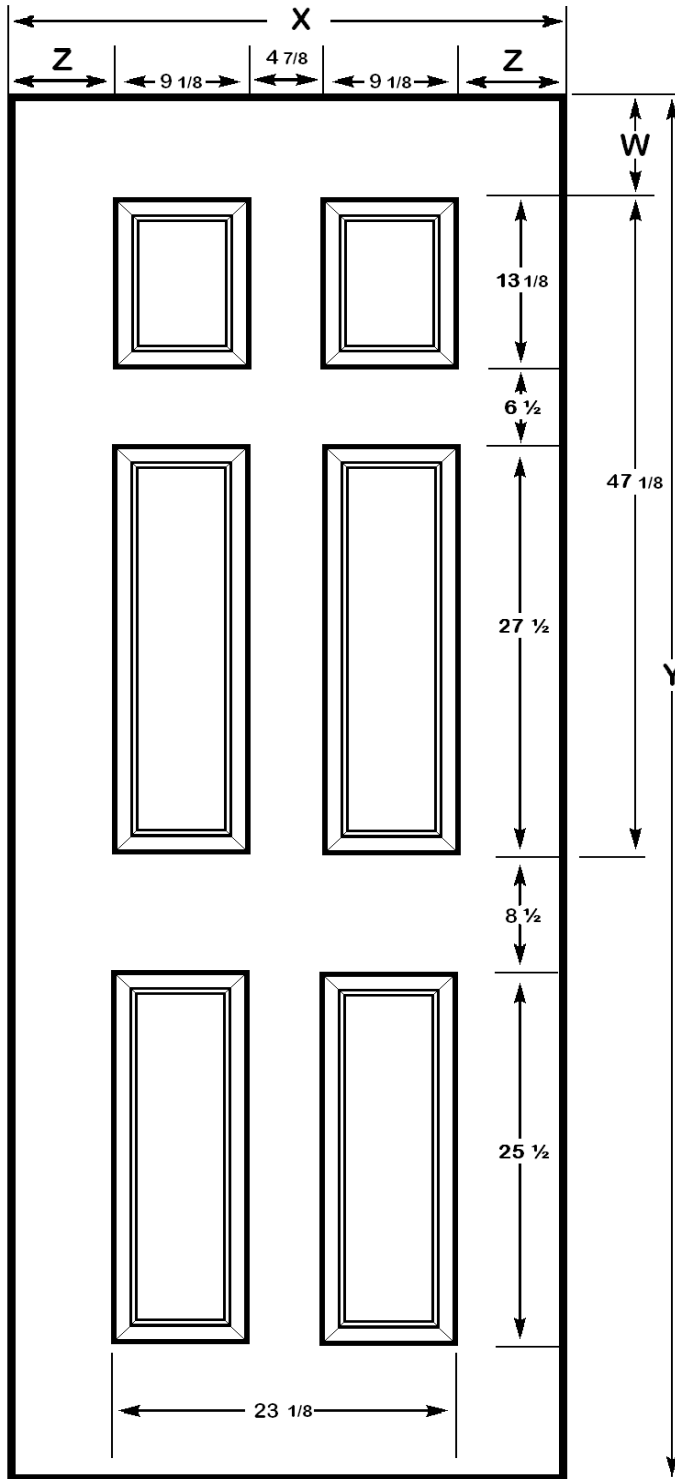

6 Panel WA600
Tall (96")
Americana Series

W =	_____
X =	_____
Y =	_____
Z =	_____

for sizes available refer to
Custom Sizing Chart

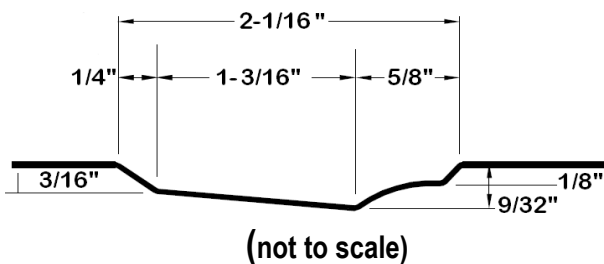

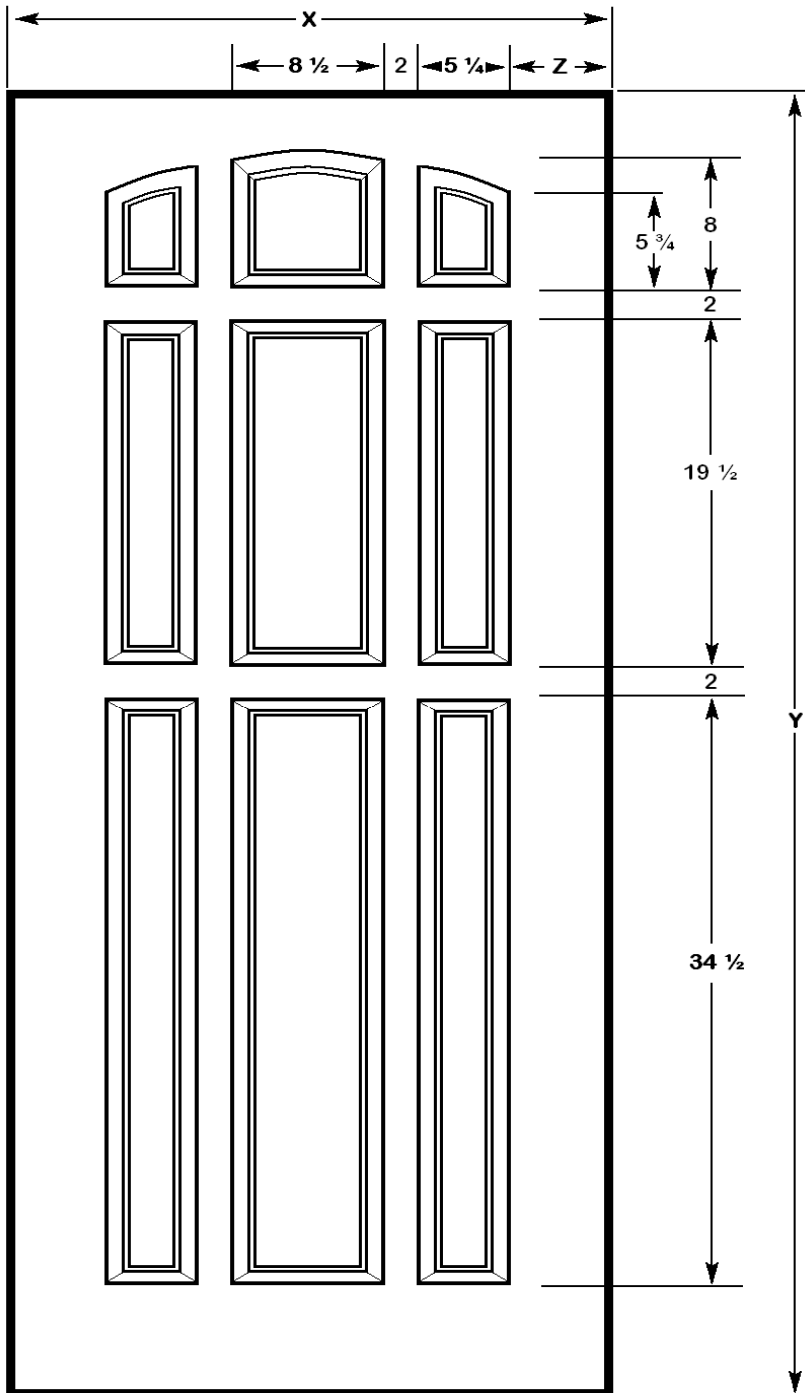

9 Panel WA900
Americana Series

W =	_____
X =	_____
Y =	_____
Z =	_____

for sizes available refer to
Custom Sizing Chart

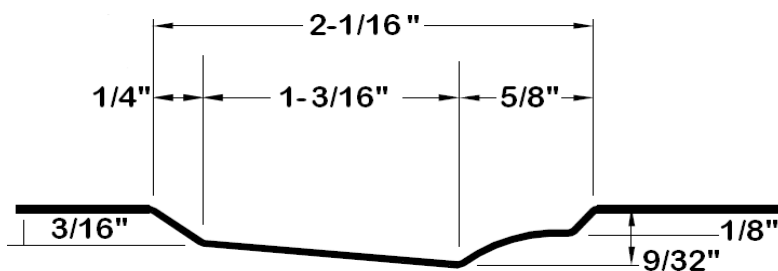

(not to scale)

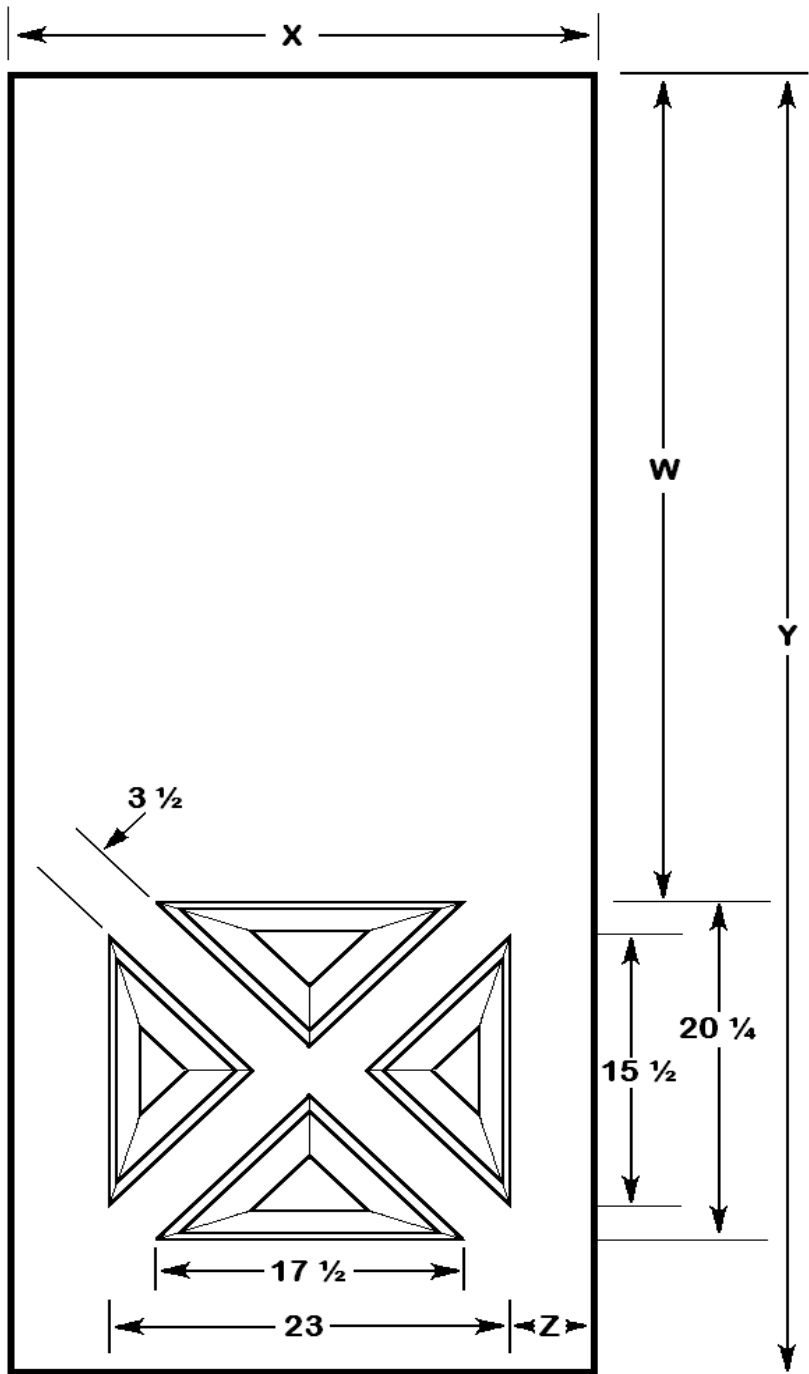

Cross Buck WXB1
Americana Series

W =	_____
X =	_____
Y =	_____
Z =	_____

for sizes available refer to
Custom Sizing Chart

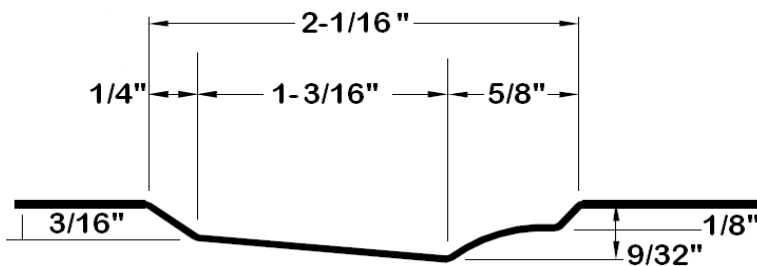

(not to scale)

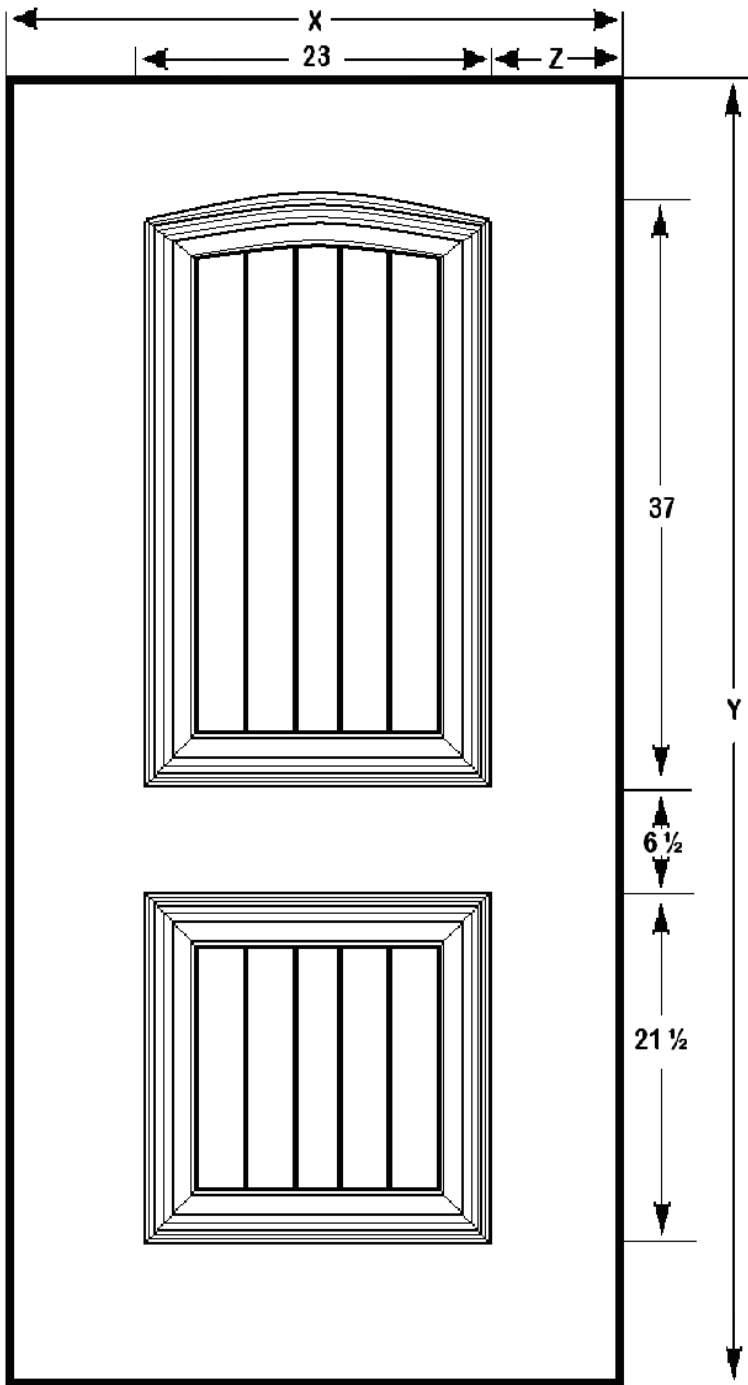

2 Panel WHD2SAP
Soft Arch Plank
Colonial Series

W =	_____
X =	_____
Y =	_____
Z =	_____

for sizes available refer to
Custom Sizing Chart

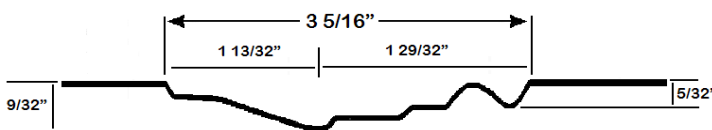

(not to scale)

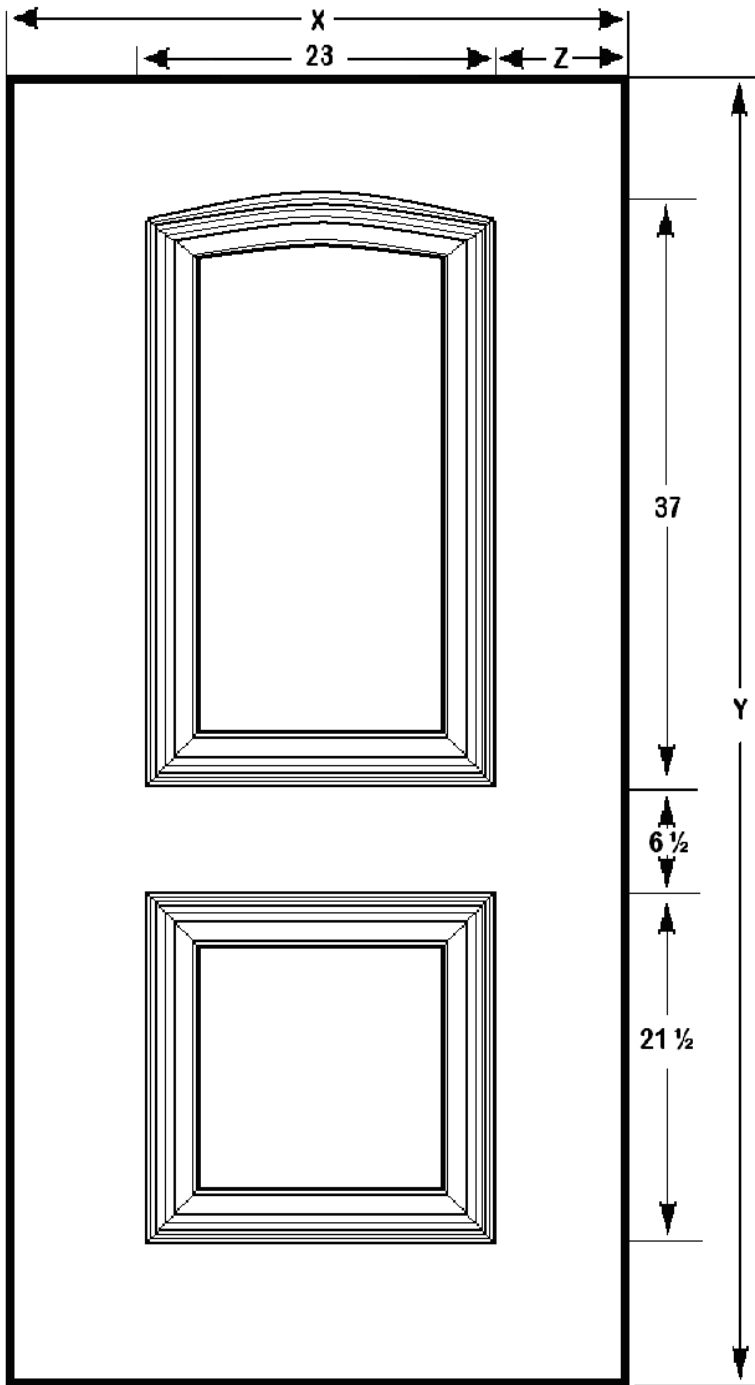

2 Panel WHD2SAS
Soft Arch Smooth
Colonial Series

W =	_____
X =	_____
Y =	_____
Z =	_____

for sizes available refer to
Custom Sizing Chart

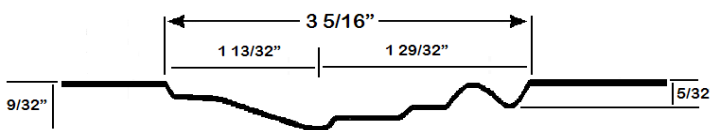

(not to scale)

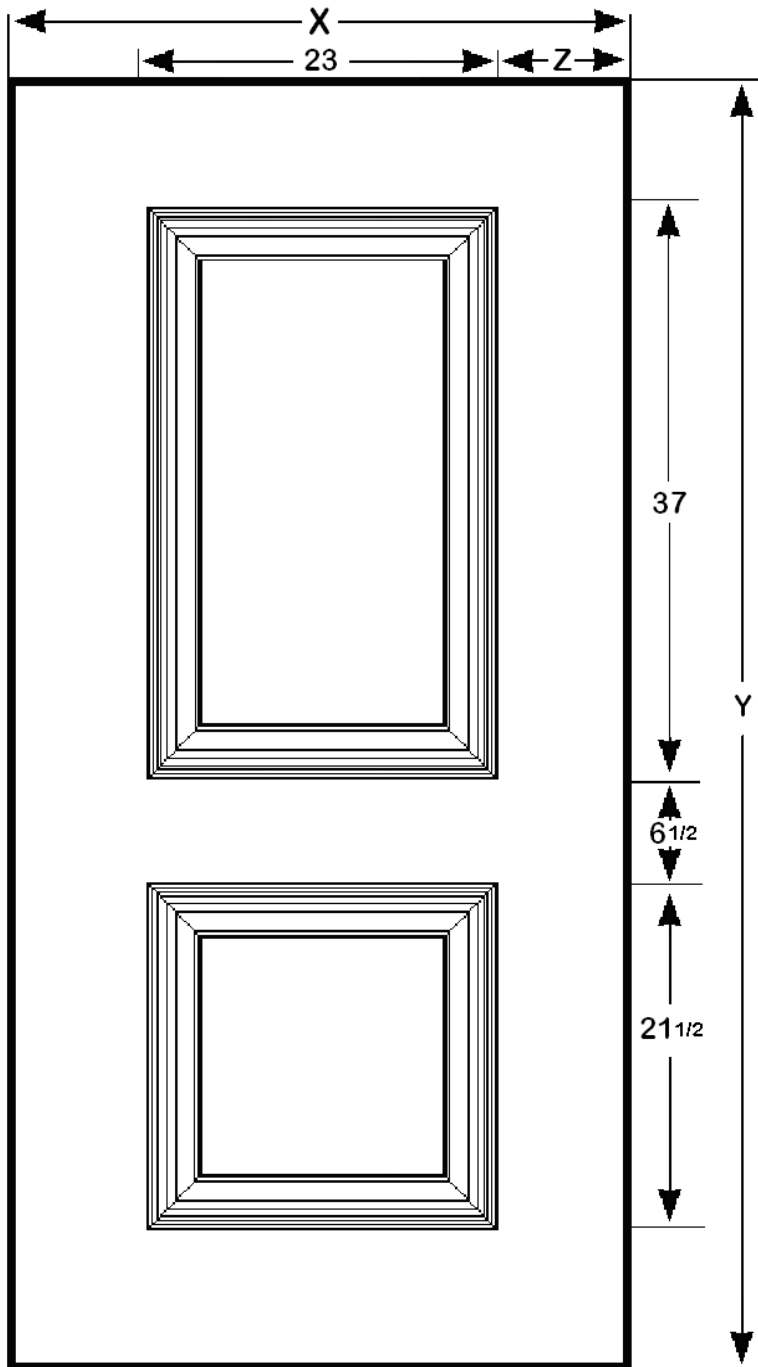

2 Panel WHD200
High Definition
Colonial Series

W =	_____
X =	_____
Y =	_____
Z =	_____

for sizes available refer to
Custom Sizing Chart

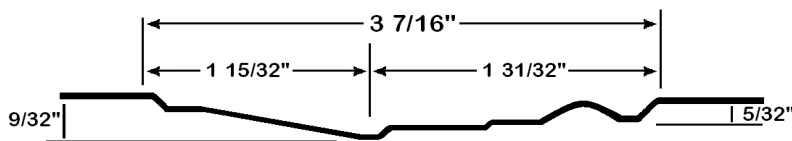

(not to scale)

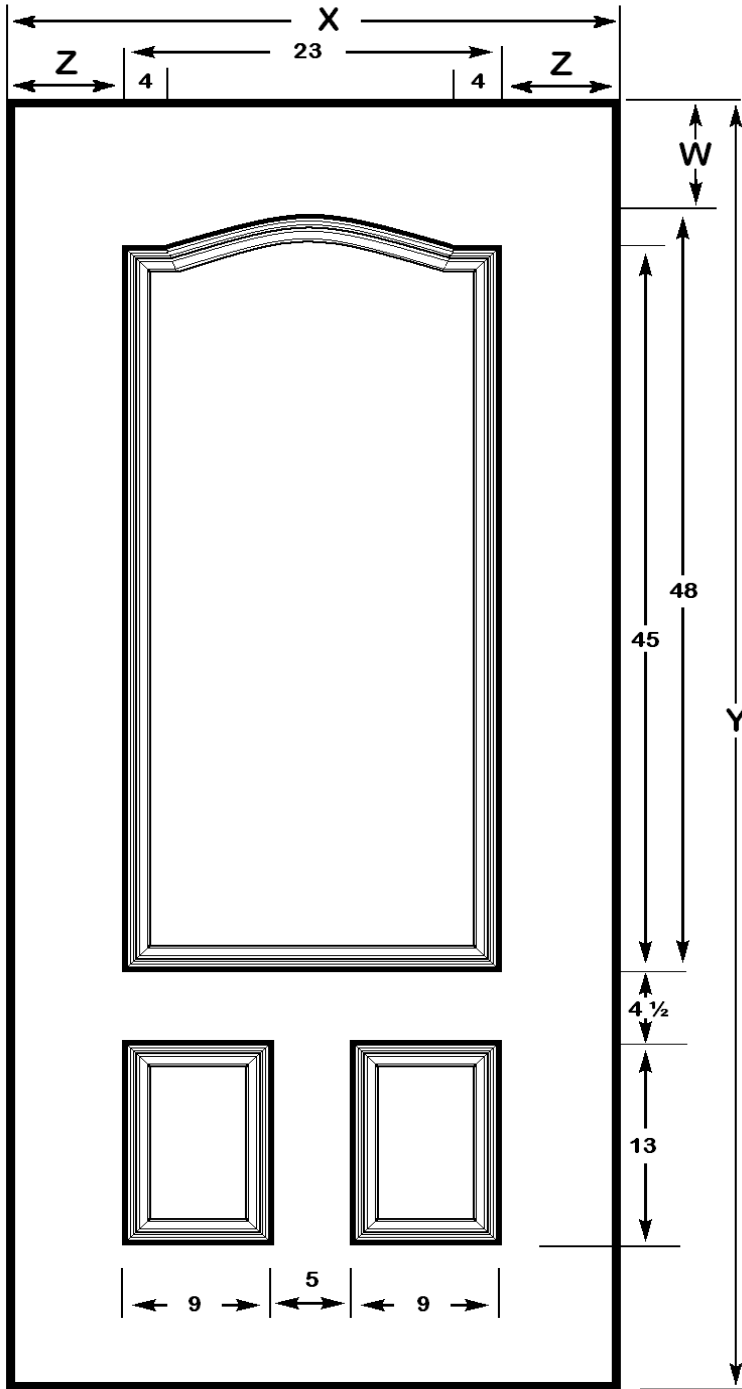

3 Panel WHD300
High Definition
Colonial Series

W =	_____
X =	_____
Y =	_____
Z =	_____

for sizes available refer to
Custom Sizing Chart

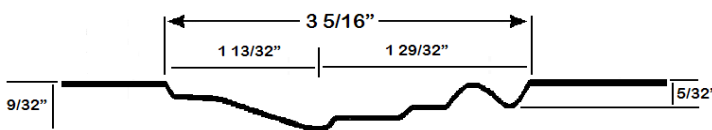

(not to scale)

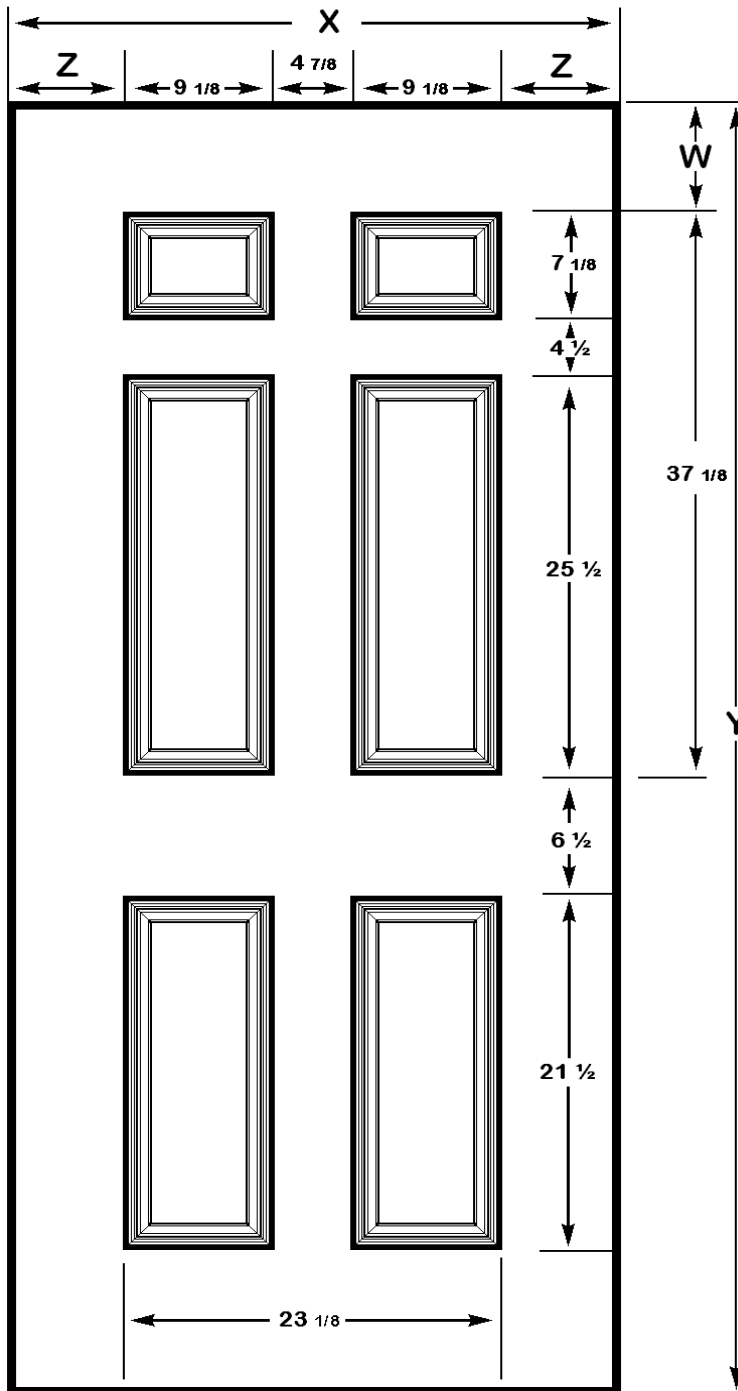

6 Panel WHD600
High Definition
Colonial Series

W =	_____
X =	_____
Y =	_____
Z =	_____

for sizes available refer to
Custom Sizing Chart

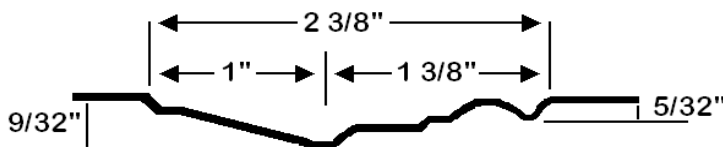

(not to scale)